

# **PARTS LIST**

**\* \* \* \* \***

**MODEL: MILLEPUNTI M220**

1

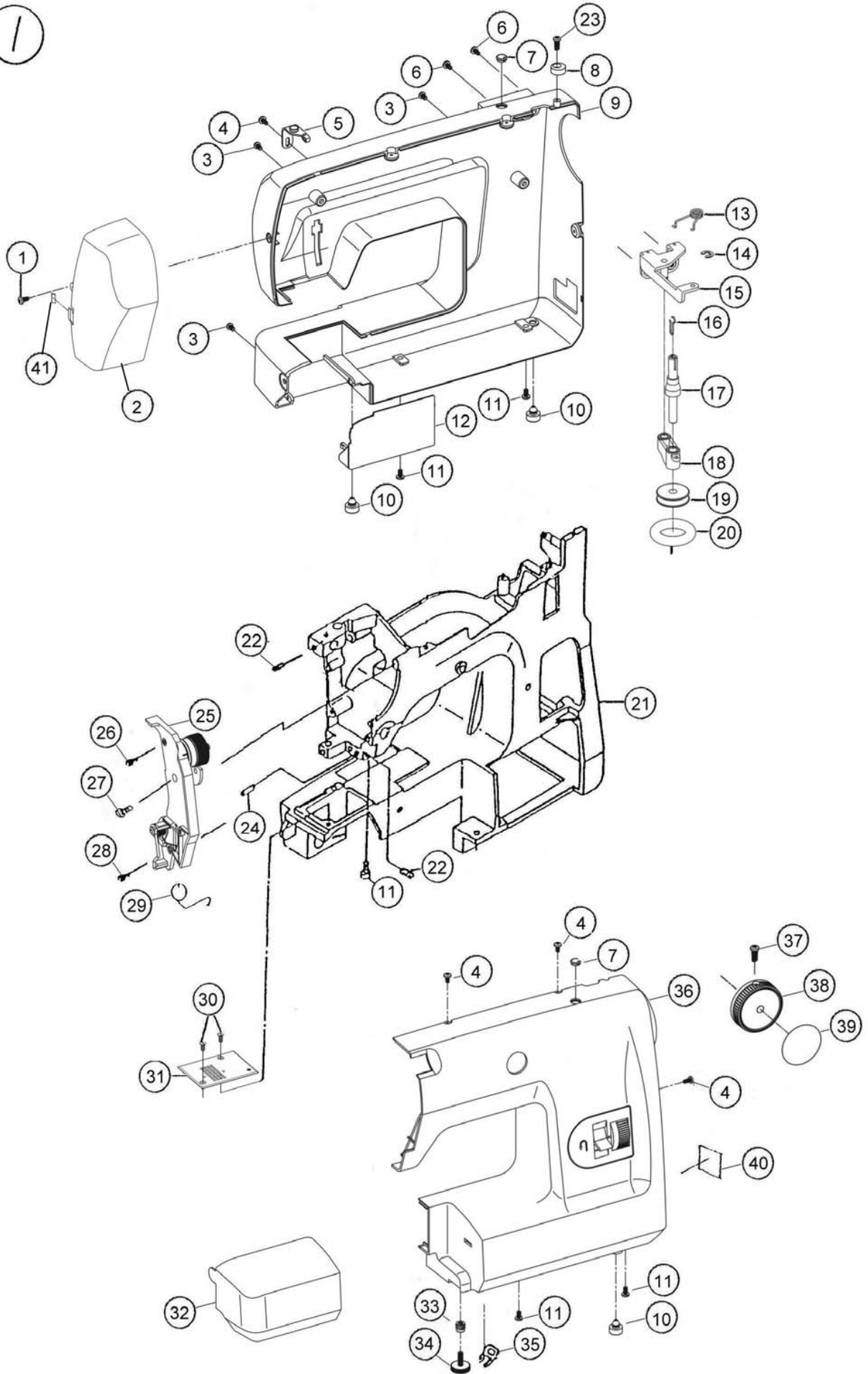

ref no.	sunbeen part no.	name of parts
01	000011004	SET SCREW
02	220145143	FACE PLATE
03	301008000	SET SCREW
04	000011912	SET SCREW
05	220501004	THREADER BASE COMP.
06	000016032	SCREW
07	250125058	ADJUSTING HOLE PLUG
08	220062008	BOBBIN STOPER
09	220051004	REAR COVER
10	250020007	RUBBER
11	250087002	SET SCREW
12	220037004	REAR COVER
13	250045008	BOBBIN WINDER SPRING C
14	000000309	SNAP RING 5D
15	220015006	WINDER FIXED PLATE
16	301022000	BOBBIN WINDER SHAFT PIN
17	220014005	BOBBIN CRANK
18	220013004	BOBBIN WINDER
19	353029101	COIL
20	353030002	RUBBER RING
21	250510009	250 ARM/BED
22	301046000	SET SCREW
23	000011222	SET SCREW
24	250013007	LEAD SHAFT
25	220612009	UPPER TENSION COMP.
26	355026001	SET SCREW
27	301008000	SET SCREW
28	260035006	SET SCREW
29	230008007	TENSION CHECK SPRING
30	301261003	SET SCREW
31	250006007	NEEDLE PLATE
32	220036003	EXTENSION TABLE PLATE
33	220060006	NUT
34	250023103	ADJUSTING FOOT
35	353049004	PANEL FIXATION
36	220156103	FRONT COVER (DRAWING)
37	370048006	HINGED SCREW
38	260027038	SELECTOR DIAL
39	260045205	SELECT DIAL INDICATED PLATE
40	220229304	RATING PLATE
41	100114001	CUTTER PLATE

2

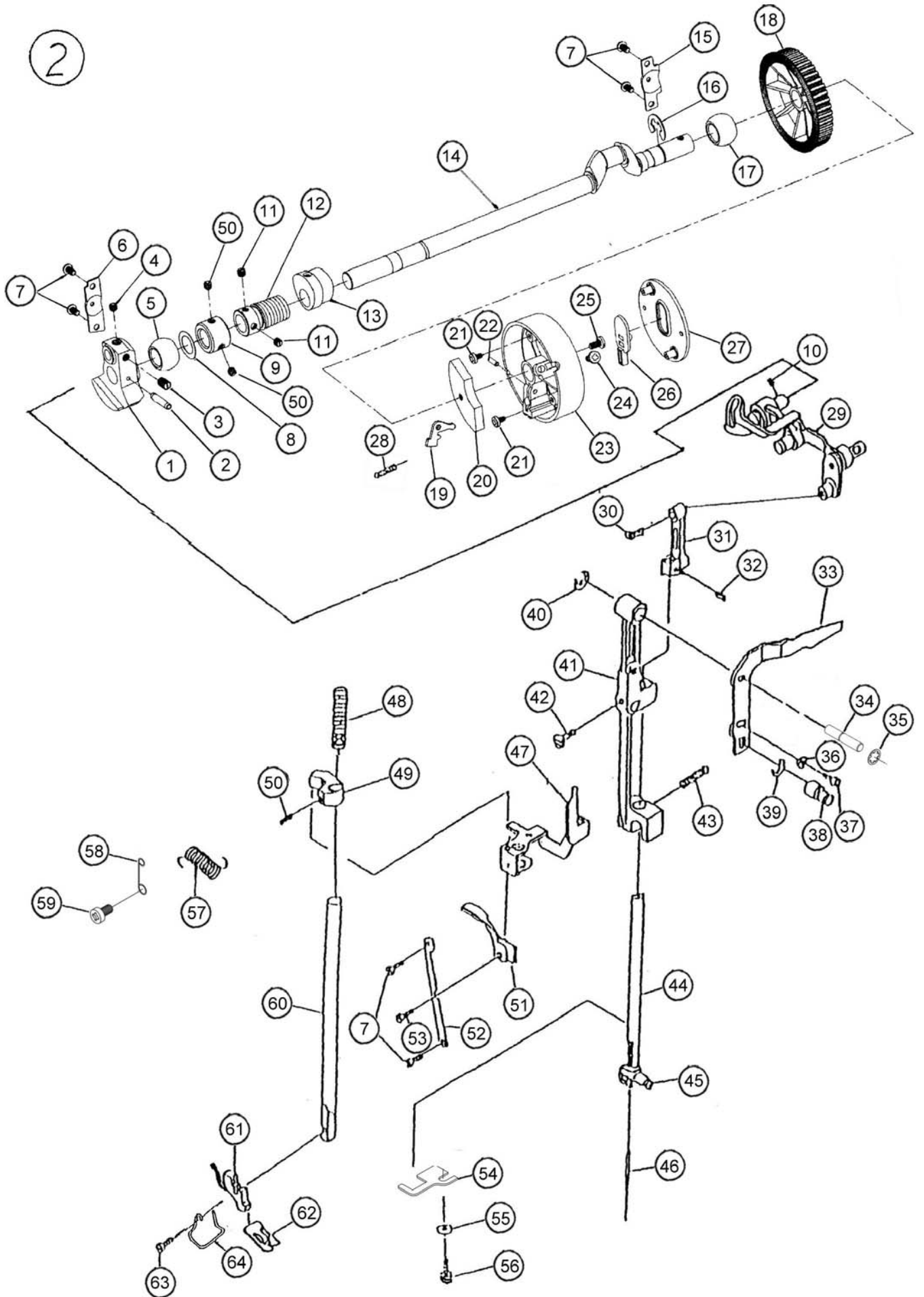

ref no.	sunbeen part no.	name of parts
01	301083009	THREAD TAKE-UP CRANK
02	000003508	SPRING PIN 4*20
03	301084103	SET SCREW
04	301068101	SET SCREW
05	250002003	FRONT BUSHING
06	250004005	FRONT BUSHING BRACKET
07	301008000	SET SCREW
08	301086002	NYLON WASHER
09	301340306	COLLAR
10	301046000	SET SCREW
11	301093105	UPPER SHAFT SET SCREW
12	303001308	UPPER SHAFT GEAR
13	370504005	SELECT CAM COMP
14	220001009	UPPER SHAFT
15	250005006	REAR BUSHING BRACKET
16	000000907	E RING UPPER SHAFT
17	250002003	FRONT BUSHING
18	220196002	MOTOR BELT
19	220004002	WHEEL TRANSPORT PLATE
20	220008006	BALANCE PLATE
21	000011222	SET SCREW
22	220005003	TRANSPORT PIN
23	220003001	HAND WHEEL
24	250010004	SCREW
25	250087002	SET SCREW
26	220006004	CLUTCH BUTTON
27	220007005	WHEEL COVER
28	610100000	SPRING
29	301544003	TAKE-UP LEVER CAMP
30	301100003	SET SCREW
31	301503000	NEEDLE HOLDER
32	301046000	SET SCREW
33	301043007	ZIGZAG DRIVING PLATE
34	220028002	SUPPORTER
35	000012326	RING
36	301245001	WASHER
37	301016001	SET SCREW
38	301045009	ECCENTRIC PIN
39	000000206	SNAP RING 4D
40	000000309	SNAP RING 5D
41	250089004	NEEDLE BAR SUPPORTER
42	301016001	SET SCREW
43	301047001	SPRING
44	260042006	NEEDLE BAR
45	260502009	NEEDLE CLAMP COMP
46	301244206	NEEDLE
47	230010002	TENSION RELEASE LEVER *A
48	290026007	SPRING
49	301559001	GUIDE BRACKET
50	301087003	SET SCREW
51	370154006	PRESSER BAR LIFTER
52	250007008	PRESSURE BAR LIFTER
53	301070003	HINGED SCREW 4
54	220030007	NEEDLE BAR STOPPING PLATE
55	301245001	WASHER
56	301049003	SET SCREW
57	370147006	SPRING
58	271094007	TENSION SPRING SETTER
59	301008000	SET SCREW
60	301061001	PRESSER BAR
61	301522005	PRESSER FOOT HOLDER
62	353012008	ZIGZAG PRESSER FOOT
63	610012004	SCREW
64	353078002	FINGER PROTECTOR

3

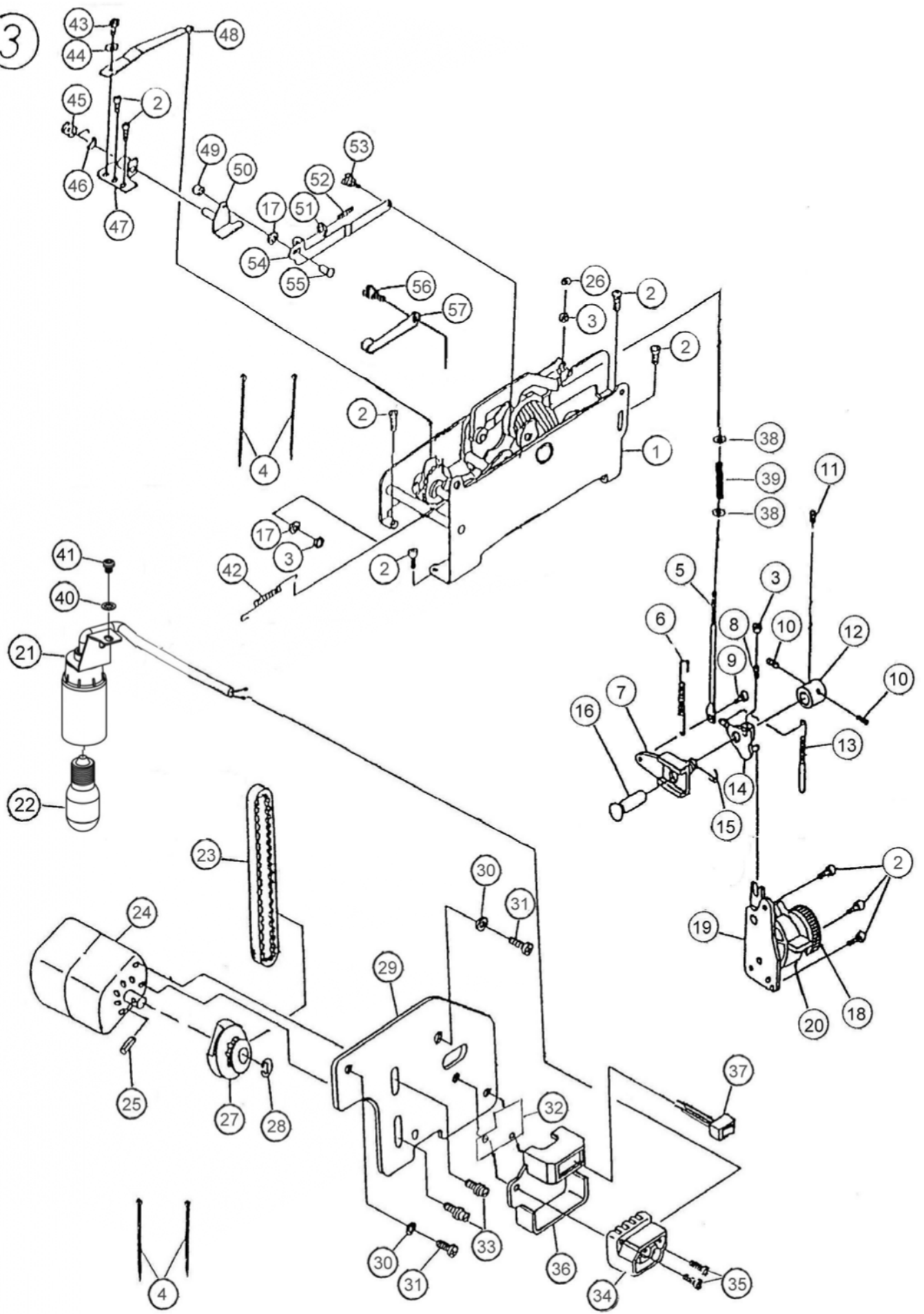

ref no.	sunbeen part no.	name of parts
01	270627208	PATTERN COMP.
02	301008000	SET SCREW
03	301151009	NUT
04	351047006	BAND
05	303002000	STRETCH STITCH ROD
06	301155003	SPRING
07	220113005	ADJUSTER
08	301289007	SET SCREW
09	301154002	HINGED SCREW
10	301046000	SET SCREW
11	301087003	SET SCREW
12	301153104	COLLAR
13	303003001	SPRING
14	220114006	ADJUSTING PLATE
15	000000505	SNAP RING 9D
16	301152000	FEED REGULATOR SHAFT
17	301245001	SET SCREW
18	230003909	STITCH LENGTH DIAL
19	270655537	STITCH LENGTH DIAL COMP.
20	380024052	REVERSE BUTTON
21	220801007	LIGHT CORD COMP.
22	650816103	LIGHT BULB
23	220197003	BELT
24	230813003	MOTOR COMP. (FDM 230V)
25	000003807	SPRING PIN 2*14
26	250146000	NUT
27	301555007	MOTOR WHEEL COMP.
28	000000103	SNAP RING 3D
29	260025003	MOTOR BRACKET
30	450063008	SPRING WASHER
31	301143008	SET SCREW
32	260050007	INSULATED PLATE
33	000063023	SET SCREW
34	000063034	RECEPTACLE
35	000063001	SCREW
36	260026107	SWITCH FIXED PLATE
37	250831009	SWITCH COMP
38	370044002	WASHER
39	370043001	ROD SPRING
40	301037008	SET SCREW
41	301257006	WAVE WASHER
42	250042005	ZIGZAG DRIVING SPRING
43	356017002	SET SCREW
44	301009001	WASHER
45	301215002	SPRING
46	000000206	SNAP RING 4D
47	250012006	ZIGZAG MECHANISM
48	356006008	SPRING PLATE(MODEL
49	301213000	SLIDE BLOCK
50	354004000	CONNECTING CRANK
51	301151009	NUT
52	301196006	SET SCREW
53	301218005	HINGED SCREW
54	303005003	ZIGZAG CONNECTING ROD
55	301212009	RIVETING PIN
56	355010002	HINGED SCREW
57	356602000	ZERO ADJUSTING CRANK

**PREFISSO '5930''**

**PREFISSO '5930''**

**PREFISSO '5930''**

4

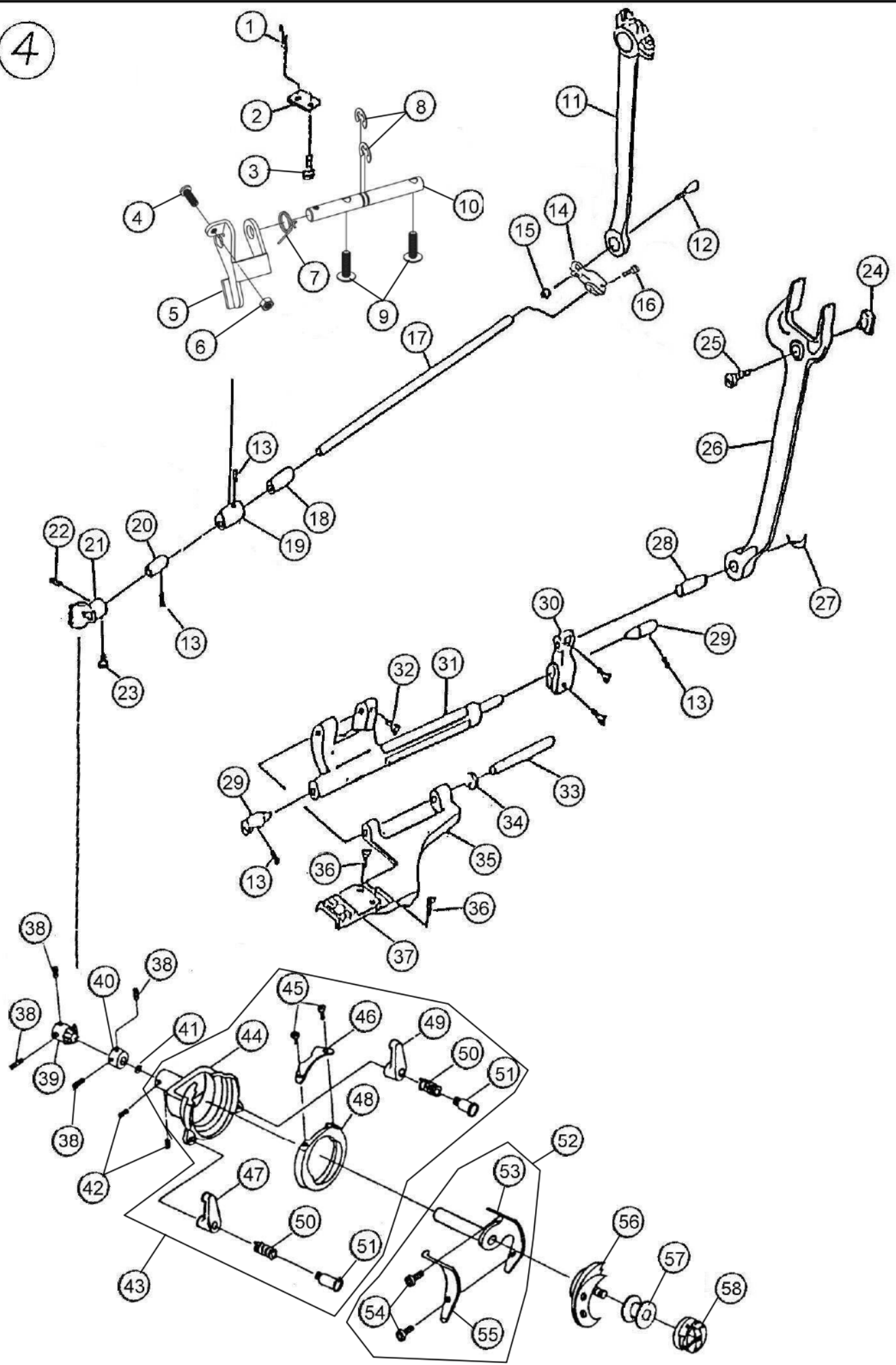



ref no. ---	sunbeen part no. -----	name of parts -----
01	301181008	FEED DOG BASE SPRING
02	301197007	SPRING HOLDER
03	301185002	SET SCREW
04	220012003	SET SCREW
05	220011002	DROP FEED CRANK
06	301151009	NUT
07	301195005	SPRING
08	000000309	SNAP RING 5D
09	250010004	SET SCREW
10	220010001	UP/DOWN SHAFT
11	301512002	CRANK ROD COMP
12	301106009	TAPER SCREW
13	301087003	SET SCREW
14	271136002	LOWER SHAFT BRACKET
15	301107000	NUT
16	000020017	SCREW
17	301109002	LOWER SHAFT
18	301110006	LOWER SHAFT FRONT BUSHING
19	301182102	FEED LIFTING CAM
20	301111100	LOWER SHAFT REAR BUSHING
21	301113009	OSCILLATING SHAFT GEAR
22	301115104	SET SCREW
23	301114103	SET SCREW
24	301147002	FORKED ROD SLIDE BLOCK
25	301146001	FORKED ROD SLIDE BLOCK DRAFT
26	301145000	FORKED ROD
27	000000402	SNAP RING 6D
28	301179003	CONNECTING PIN
29	301241007	CENTER PIN B
30	301517007	FEED ROCK CRANK
31	301171005	FEED ROCK SHAFT
32	301131003	SET SCREW
33	301173007	FEED DOG BASE SHAFT
34	000000206	SNAP RING 4D
35	301172006	FEED DOG BASE
36	301175009	SET SCREW
37	301174008	FEED DOG
38	301046000	SET SCREW
39	301130105	BEVEL GEAR
40	301129101	COLLAR
41	301128007	NYLON WASHER
42	301087003	SET SCREW
43	301542207	HOOK RACE BODY COMP.
44	301328205	HOOK RACE BODY
45	301123105	SET SCREW
46	301312103	SPRING
47	301119108	CLASP (LEFT)
48	301313104	HOOK RACE COVER
49	301118107	CLASP (RIGHT)
50	301120102	CLASP SPRING
51	301121103	HINGED SCREW
52	301541000	HOOK RACE SHAFT COMP.
53	301329000	HOOK DRIVER BODY
54	301127006	SET SCREW
55	301126005	HOOK DRIVER SPRING
56	301132406	HOOKPANEL
57	610081004	BOBBIN
58	301515304	BOBBIN CASE

5

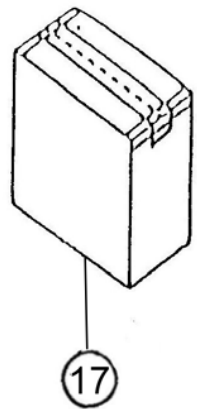
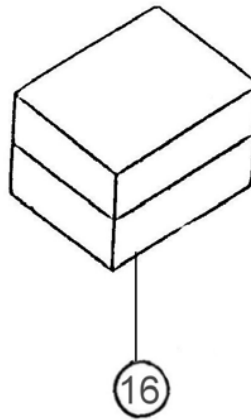
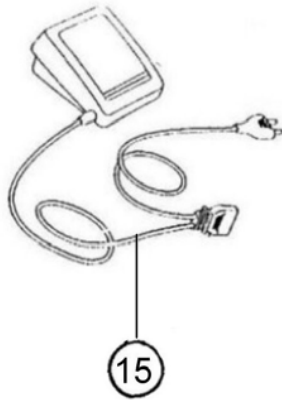
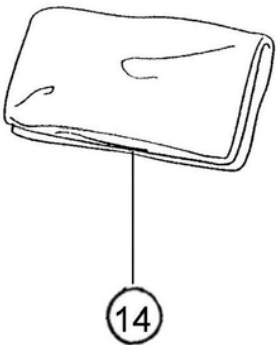
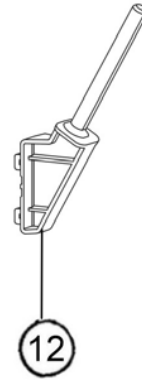
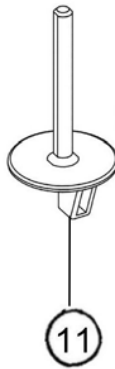
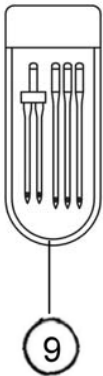
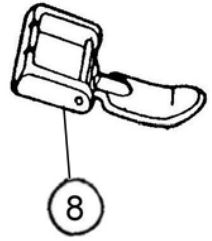
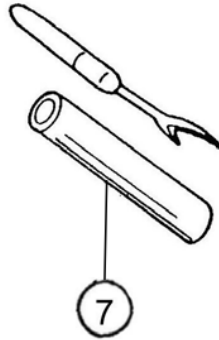
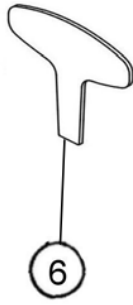
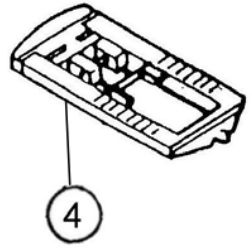
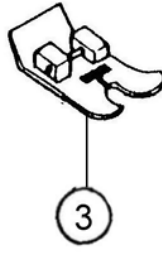
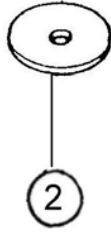

ref no. ---	sunbeen part no. -----	name of parts -----
01	610081004	BOBBIN
02	301403009	FELT
03	353012008	ZIGZAG PRESSER FOOT (SUR LA MACHINE)
04	303401003	BUTTONHOLE FOOT
05	301439004	SCREW DRIVER (L)
06	660403001	SCREW DRIVER
07	303403201	BUTTONHOLE KNIFE
08	301438003	ZIPPER FOOT
09	270660502	NEEDLE BAG COMP.
10	220401003	NEEDLE PLATE
11	220405007	SPOOL PIN (A)
12	220406008	SPOOL PIN (B)
13	220426201	INSTRUCTION MANUAL
14	353435805	DUST COVER
15	230814004	CONTROLLER COMP.
16	220434005	POLYFOAM COMP
17	220732028	CARTON

**PREFISSO "5930"**